

Replacement Parts
for
Raymond 7400, 7420, 7440 Series

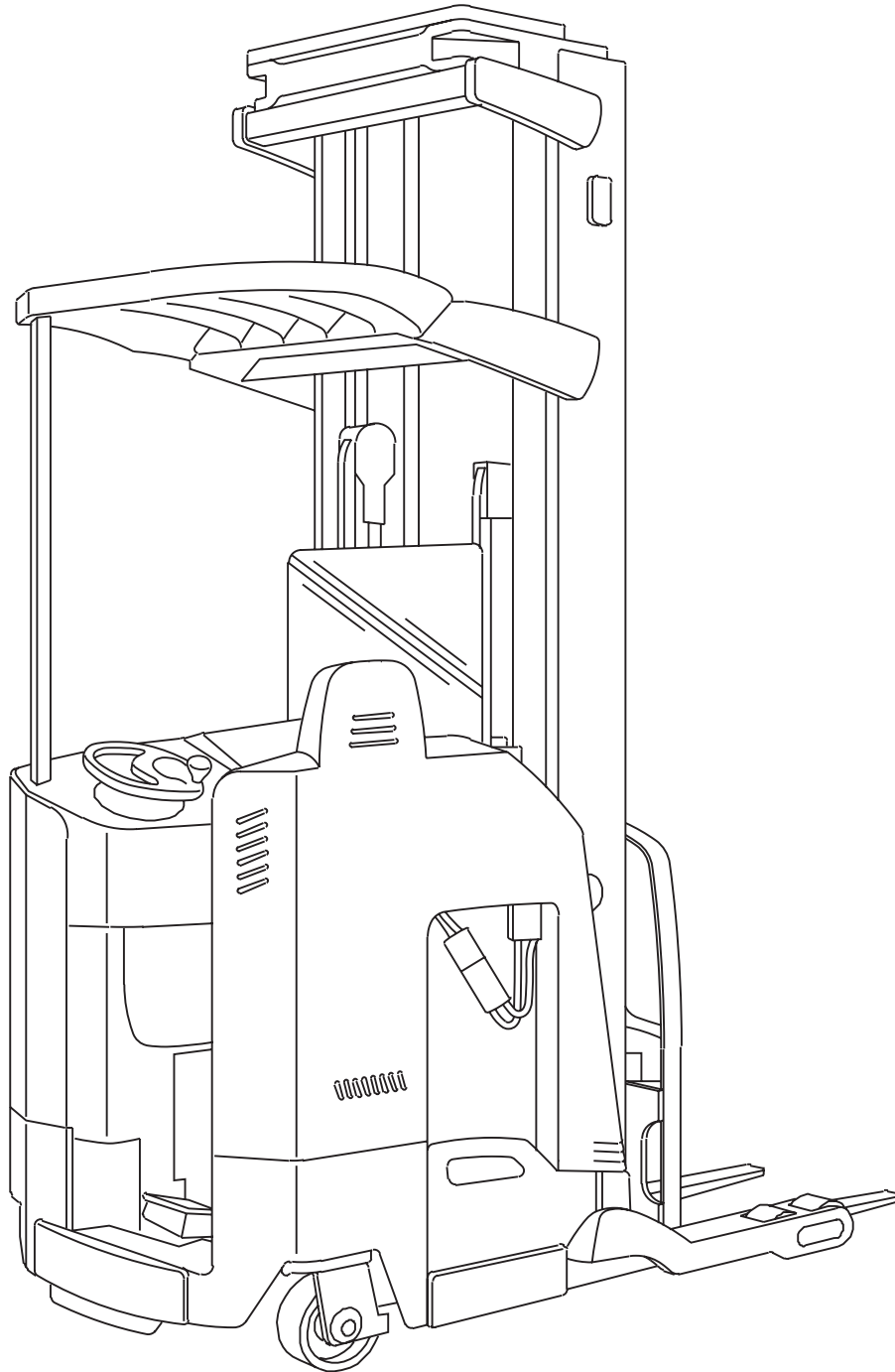



Contents

Quick Wheel Lookup	4
Open Toe Wheel Plates & Load Wheels	6
Closed Toe Wheel Plates & Load Wheels	8
Drive Tire	10
Drive Motor & Drive Unit	12
Electric Brake Assembly	12
Hydraulics	
Lift Pump & Motor Assembly	14
Hydraulic Manifold Assembly	16
Cylinder	18
Steered Idler Wheel Assembly	20
Steering Linkage	22
Electrical System	24
Steering & Controls	26
Mast & Reach Carriage	28
Battery Compartment	30

Quick Wheel Lookup

Quick Wheel Lookup

[back to Contents](#)

OEM #	Description	Wheel OD in / mm	Tread Width in / mm	Hub Width in / mm	Hub ID in / mm	Bearing ID in / mm	Bearing #	Material/ Color
RA 632-032	Load Wheel	4.00 / 101	3.50 / 89	3.62 / 92	2.04 / 52	0.98 / 25	6205	95-A
RA 632-032-A	Load Wheel Assembly	4.00 / 101	3.50 / 89	3.62 / 92	2.04 / 52	0.98 / 25	6205	95-A
RA 632-032-XL	Load Wheel	4.00 / 101	3.50 / 89	3.62 / 92	2.04 / 52	0.98 / 25	6205	97-A XL
RA 632-032-XL-A	Load Wheel Assembly	4.00 / 101	3.50 / 89	3.62 / 92	2.04 / 52	0.98 / 25	6205	97-A XL
RA 632-031	Load Wheel	4.00 / 101	2.62 / 66	2.88 / 73	2.04 / 52	0.98 / 25	6205	95-A
RA 632-031-A	Load Wheel Assembly	4.00 / 101	2.62 / 66	2.88 / 73	2.04 / 52	0.98 / 25	6205	95-A
RA 632-031-XL	Load Wheel	4.00 / 101	2.62 / 66	2.88 / 73	2.04 / 52	0.98 / 25	6205	97-A XL
RA 632-031-XL-A	Load Wheel Assembly	4.00 / 101	2.62 / 66	2.88 / 73	2.04 / 52	0.98 / 25	6205	97-A XL
RA 632-043	Load Wheel	5.00 / 127	2.50 / 63.5	2.88 / 73	2.04 / 52	0.98 / 25	6205	95-A
RA 632-043-A	Load Wheel Assembly	5.00 / 127	2.50 / 63.5	2.88 / 73	2.04 / 52	0.98 / 25	6205	95-A
RA 632-043-XL	Load Wheel	5.00 / 127	2.50 / 63.5	2.88 / 73	2.04 / 52	0.98 / 25	6205	97-A, XL
RA 632-043-XL-A	Load Wheel Assembly	5.00 / 127	2.50 / 63.5	2.88 / 73	2.04 / 52	0.98 / 25	6205	97-A, XL
RA 632-052	Load Wheel	5.00 / 127	3.25 / 82.55	3.62 / 92	2.44 / 62	0.98 / 25	6305	95-A
RA 632-052-A	Load Wheel Assembly	5.00 / 127	3.25 / 82.55	3.62 / 92	2.44 / 62	0.98 / 25	6305	95-A
RA 632-052-XL	Load Wheel	5.00 / 127	3.25 / 82.55	3.62 / 92	2.44 / 62	0.98 / 25	6305	97-A, XL
RA 632-052-XL-A	Load Wheel Assembly	5.00 / 127	3.25 / 82.55	3.62 / 92	2.44 / 62	0.98 / 25	6305	97-A, XL
RA 632-057	Load Wheel	6.00 / 152	3.75 / 95	4.00 / 102	2.83 / 72	1.37 / 35	6207	95-A
RA 632-057-A	Load Wheel Assembly	6.00 / 152	3.75 / 95	4.00 / 102	2.83 / 72	1.37 / 35	6207	95-A
RA 632-057-XL	Load Wheel	6.00 / 152	3.75 / 95	4.00 / 102	2.83 / 72	1.37 / 35	6207	97-A, XL
RA 632-057-XL-A	Load Wheel Assembly	6.00 / 152	3.75 / 95	4.00 / 102	2.83 / 72	1.37 / 35	6207	97-A, XL
RA 632-078-A	Caster Wheel Assembly	8.00 / 203	3.75 / 95	4.00 / 102	2.44 / 62	1.18 / 30	6206	95-A
RA 632-078-XL	Caster Wheel	8.00 / 203	3.75 / 95	4.00 / 102	2.44 / 62	1.18 / 30	6206	97-A, XL
RA 632-078-XL-A	Caster Wheel Assembly	8.00 / 203	3.75 / 95	4.00 / 102	2.44 / 62	1.18 / 30	6206	97-A, XL
RA 632-131-001	Drive Tire	13.5 / 343	5.50 / 140	6.00 / 152	10.5 / 267	N/A	N/A	95-A
RA 632-131-107	Drive Tire	13.5 / 343	5.50 / 140	6.00 / 152	10.5 / 267	N/A	N/A	97-A, XL
RA 828-003-073	Hub	N/A	N/A	N/A	N/A	N/A	N/A	Cast Iron

RA 632-043-A



RA 632-043-XL



RA 632-052



RA 632-052-XL

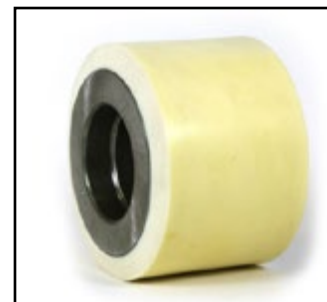

RA 632-057

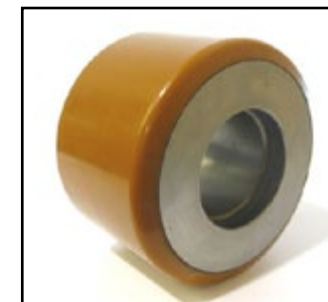

RA 632-057-A

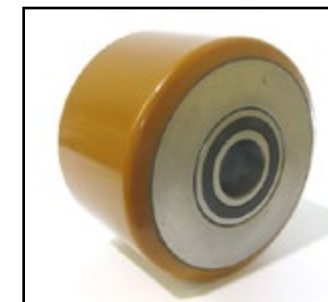

RA 632-078

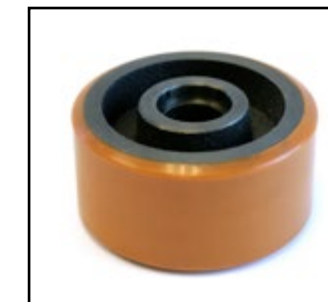

RA 828-003-073



Open Toe Wheel Plates and Load Wheels

5" Diameter Load Wheels

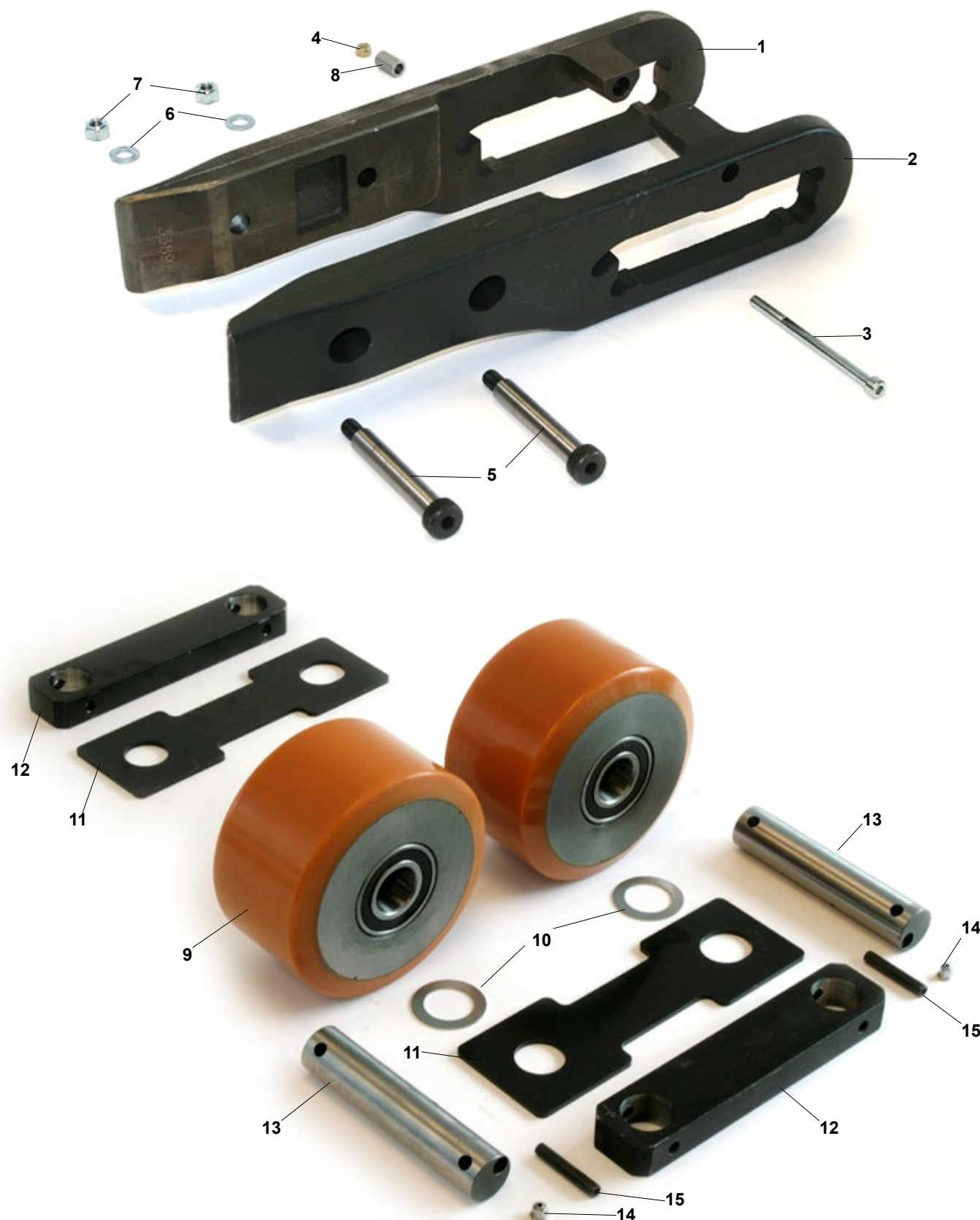

[back to Contents](#)

Open Toe Wheel Plates and Load Wheels

5" Diameter Load Wheels

Item	Part No.	Description
1	RA 1053389	Wheel Plate, Left-Hand, Open-Toe, w/ Sideshift
2	RA 1053390	Wheel Plate, Right-Hand, Open-Toe, w/ Sideshift
3	RA 1040923/005	Screw
4	RA 5-016-005	Nylon Lock Nut
5	RA 5-005-017	Shoulder Bolt
6	RA 5-018-008	Flat Washer
7	RA 5-016-017	Lock Nut
8	RA 1043118	Wheel Plate Sleeve
9	RA 632-043	Load Wheel, 5" x 2.88", 95-A
	RA 632-043-A	Load Wheel, 5" x 2.88", 95-A w/ Bearings
	RA 632-043-XL	Load Wheel, 5" x 2.88", 97-A XL
	RA 632-043-XL-A	Load Wheel, 5" x 2.88", 97-A XL w/ Bearings
	RA 632-052	Load Wheel, 5" x 3.62", 95-A
	RA 632-052-A	Load Wheel, 5" x 3.62", 95-A w/ Bearings
	RA 632-052-XL	Load Wheel, 5" x 3.62", 97-A XL
	RA 632-052-XL-A	Load Wheel, 5" x 3.62", 97-A XL w/ Bearings
10	RA 771-033	Shim, .04"
11	RA 1031101	Spacer
12	RA 623-010-109	Plate Carrier
13	RA 1014758/001	Load Wheel Axle, 2.88" Wide Load Wheel
	RA 1014758/002	Load Wheel Axle, 3.62" Wide Load Wheel
14	RA 841-111	Lube Fitting
15	RA 810-761	Spiral Pin

Closed Toe Wheel Plates and Load Wheels

All Load Wheels Except 6" x 4"

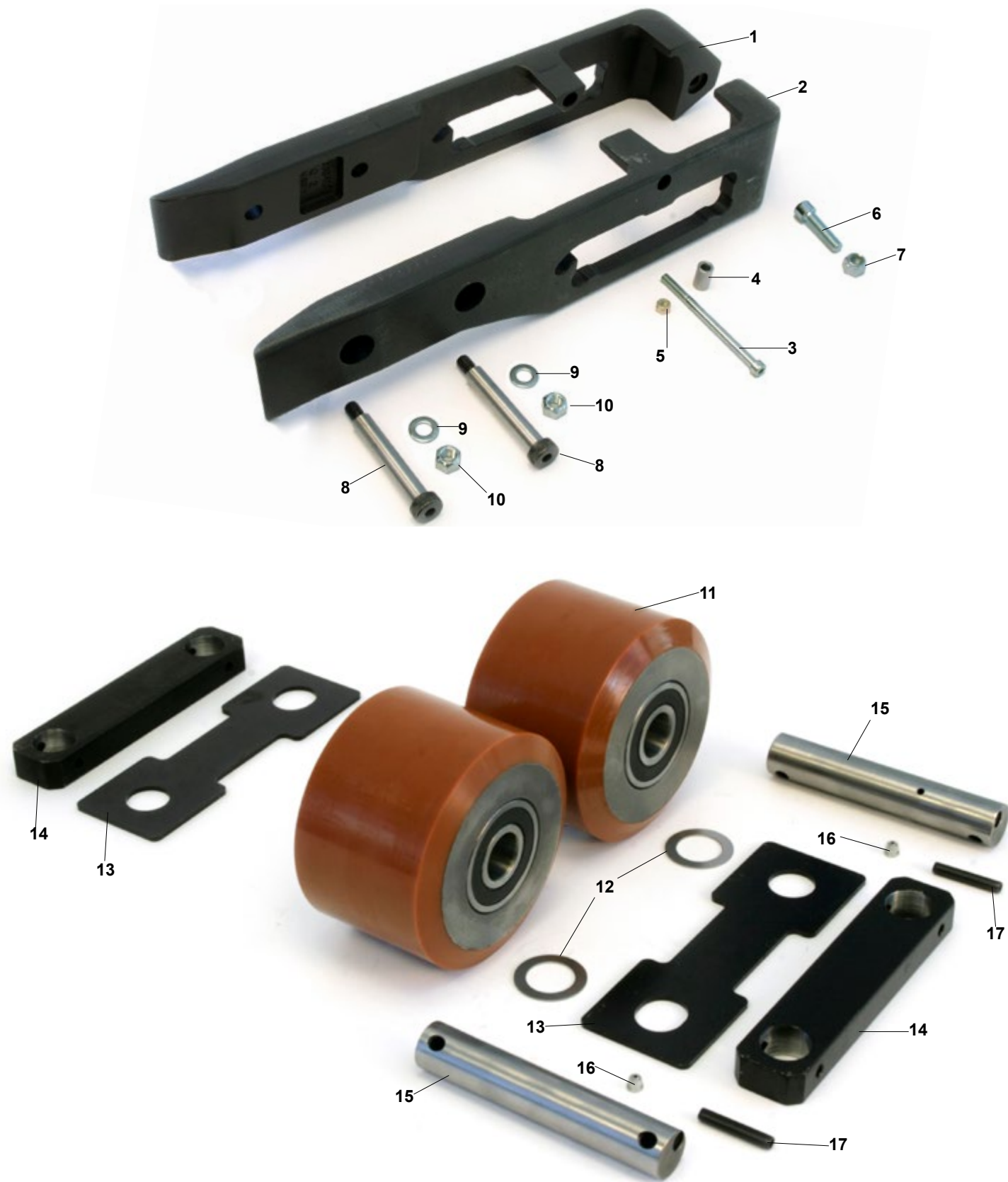

Closed Toe Wheel Plates and Load Wheels

All Load Wheels Except 6" x 4"

[back to Contents](#)

Item	Part No.	Description
1	RA 1053385	Closed Wheel Plate, Left-Hand, 5" x 3.62" Load Wheel w/ Sideshift
	RA 1049976	Closed Wheel Plate, Left-Hand, 5" x 2.88" Load Wheel w/ Sideshift
	RA 1049978	Closed Wheel Plate, Left-Hand, 4" x 3.62" Load Wheel w/ Sideshift
	RA 1049980	Closed Wheel Plate, Left-Hand, 4" x 2.88" Load Wheel w/ Sideshift
2	RA 1053386	Closed Wheel Plate, Right-Hand, 5" x 3.62" Load Wheel w/ Sideshift
	RA 1049977	Closed Wheel Plate, Right-Hand, 5" x 2.88" Load Wheel w/ Sideshift
	RA 1049979	Closed Wheel Plate, Right-Hand, 4" x 3.62" Load Wheel w/ Sideshift
	RA 1049981	Closed Wheel Plate, Right-Hand, 4" x 2.88" Load Wheel w/ Sideshift
3	RA 1040923/005	Screw, 5" x 3.62" Load Wheel
	RA 1040923/004	Screw, 4" x 3.62" Load Wheel
	RA 1040923/007	Screw, 4" x 2.88" and 5" x 2.88" Load Wheels
4	RA 1043118	Plate Sleeve, 5" Diameter Load Wheel
	RA 1051173	Plate Sleeve, 4" Diameter Load Wheel
5	RA 5-016-005	Locknut
6	RA 1040923/006	Wheel Plate Screw, 3.62" Wide Load Wheel
	RA 1040923/002	Wheel Plate Screw, 2.88" Wide Load Wheel
7	RA 1043403/005	Locknut
8	RA 5-005-017	Shoulder Bolt, 3.62" Wide Load Wheel
	RA 1064424	Shoulder Bolt, 2.88" Wide Load Wheel
9	RA 5-018-008	Flat Washer
10	RA 5-016-017	Locknut
11	RA 632-052	Load Wheel, 5" x 3.62", 95-A

Item	Part No.	Description
	RA 632-052-A	Load Wheel, 5" x 3.62", 95-A w/ Bearings
	RA 632-052-XL	Load Wheel, 5" x 3.62", 97-A XL
	RA 632-052-XL-A	Load Wheel, 5" x 3.62", 97-A XL w/ Bearings
	RA 632-043	Load Wheel, 5" x 2.88", 95-A
	RA 632-043-A	Load Wheel, 5" x 2.88", 95-A w/ Bearings
	RA 632-043-XL	Load Wheel, 5" x 2.88", 97-A XL
	RA 632-043-XL-A	Load Wheel, 5" x 2.88", 97-A XL w/ Bearings
	RA 632-032	Load Wheel, 4" x 3.62", 95-A
	RA 632-032-A	Load Wheel, 4" x 3.62", 95-A w/ Bearings
	RA 632-032-XL	Load Wheel, 4" x 3.62", 97-A XL
	RA 632-032-XL-A	Load Wheel, 4" x 3.62", 97-A XL w/ Bearings
	RA 632-031	Load Wheel, 4" x 2.88", 95-A
	RA 632-031-A	Load Wheel, 4" x 2.88", 95-A w/ Bearings
	RA 632-031-XL	Load Wheel, 4" x 2.88", 97-A XL
	RA 632-031-XL-A	Load Wheel, 4" x 2.88", 97-A XL w/ Bearings
12	RA 771-033	Shim, .04"
	RA 771-040	Shim, .31"
13	RA 1031101	Spacer, 5" Diameter Load Wheel
	RA 1022987	Spacer, 4" Diameter Load Wheel
14	RA 623-010-109	Plate Carrier, 5" Diameter Load Wheel
	RA 828-008-202	Plate Carrier, 4" Diameter Load Wheel
15	RA 1014758/002	Load Wheel Axle, 3.62" Wide Load Wheel
	RA 1014759/001	Load Wheel Axle, 2.88" Wide Load Wheel
16	RA 841-111	Lube Fitting
17	RA 810-761	Spiral Pin

Drive Tire

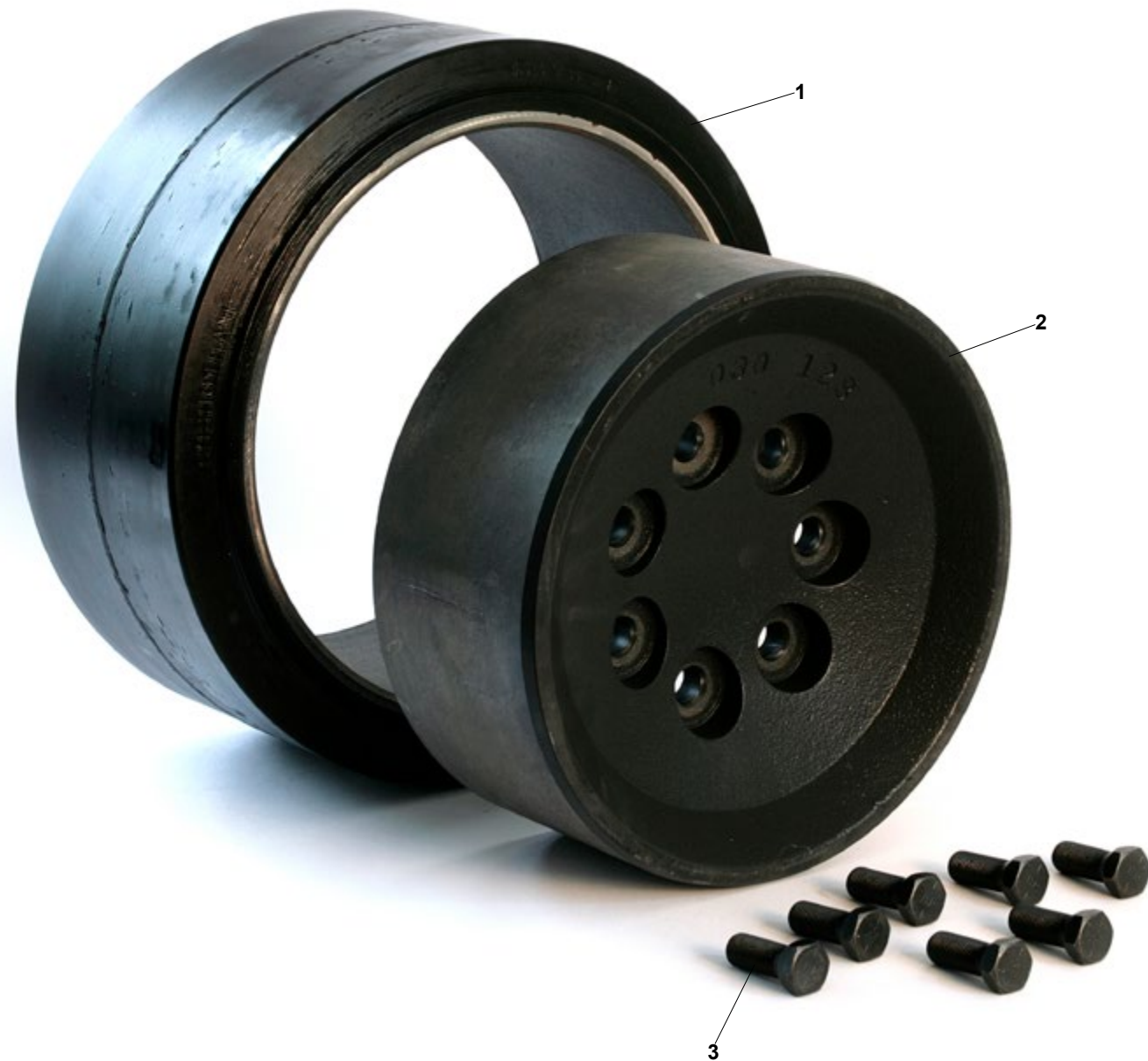

Drive Tire

[back to Contents](#)

Item	Part No.	Description
1	RA 632-131-001	Drive Tire, Poly 95-A
	RA 632-131-107	Drive Tire, Poly 97-A
2	RA 828-003-073	Drive Wheel Hub
3	RA 828-003-193	Lug Bolt

Drive Motor & Drive Unit



Electric Brake Assembly



Drive Motor & Drive Unit

[back to Contents](#)

Item	Part No.	Description
1	RA 1029753/600	AC Drive Motor, AC (Danaher TSW) Model 7400 (not shown)
2	RA 1038442/700	AC Drive Motor, UL Class E (Sauer Danfoss, not shown) Models 7400 & 7420
3	RA 1029754/600	AC Drive Motor, UL Class EE (Danaher TSW Motor, not shown) Model 7400 EE
4	RA 401-175	Pinion Gear
5	RA 828-013-978	Drive Motor Gasket
6	RA 1030934	Ring Set Kit
7	RA 410-022/06	Drive Axle

Electric Brake Assembly

Item	Part No.	Description
8	RA 1065061/KIT	Electric Brake Assembly
9	RA 1065061/01	Magnet Body Sub-Assembly
10	RA 1065061/010	Compression Spring
11	RA 1065061/09	Friction Carrier
12	RA 1065061/011	Pads

Hydraulics - Lift Pump and Motor Assembly

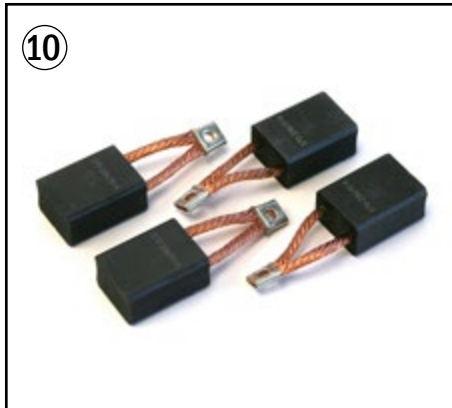
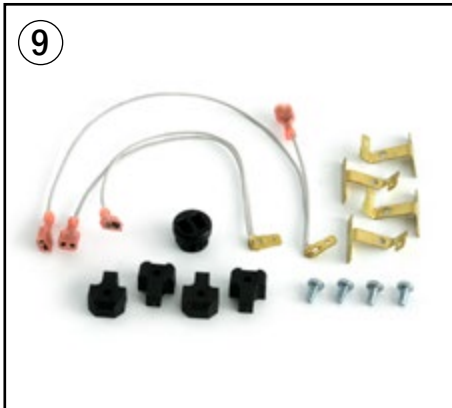
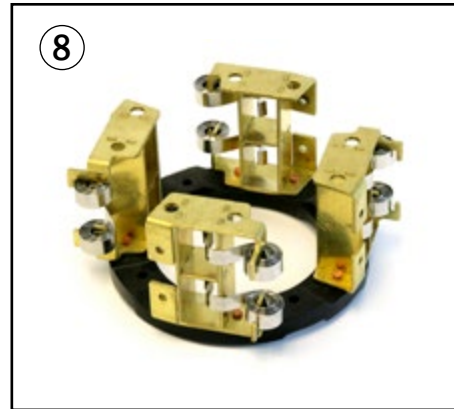
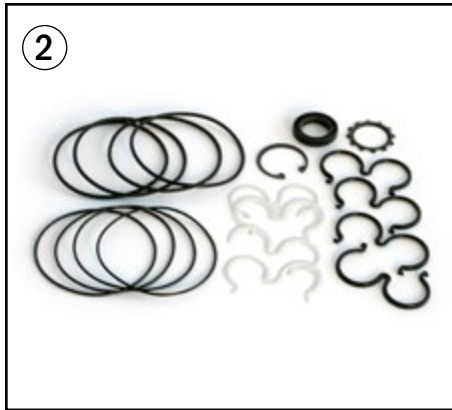

Hydraulics - Lift Pump and Motor Assembly

[back to Contents](#)

Item	Part No.	Description
------	----------	-------------

Lift Pump and Motor Assembly, DC

1	RA 500-348/367	Lift Pump, Seal Kit, Single DC Lift Pump
2	RA 500-444/211	Lift Pump, Seal Kit, Dual DC Lift Pump
3	RA 1008685/500	DC Lift Motor, Class E (not shown)
4	RA 1019386/500	DC Lift Motor, Class EE (not shown)
5	RA 570-252/518	DC Lift Motor, Wavy Washer
6	RA 570-445/215	DC Lift Motor, Bearing
7	RA 1008685/518	DC Lift Motor, Lead Kit Assembly
8	RA 1008685/514	DC Lift Motor, Brush Holder Assembly
9	RA 1008685/517	DC Lift Motor, Brush Wear Indicator
10	RA 570-604/512	DC Lift Motor, Brush Set
11	RA 570-446/516	DC Lift Motor, Brush Spring Set
12	RA 570-240/215	DC Lift Motor, Drive End Bearing

Lift Pump and Motor Assembly, AC

13	RA 1052117/07	AC Lift Motor, Drive Bearing
14	RA 1052117/09	AC Lift Motor, Shaft Seal (not shown)
15	RA 1052117/16	AC Lift Motor, Motor Speed Encoder Bearing Assembly
16	RA 1034060/85	AC Lift Motor, O-Ring (not shown)

Hydraulics - Hydraulic Manifold Assembly

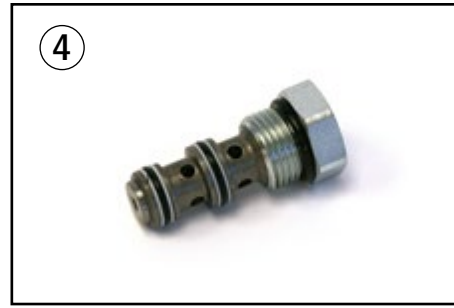

Hydraulics - Hydraulic Manifold Assembly

[back to Contents](#)

Item	Part No.	Description
1	RA 1015361/001	Proportional Valve, Lift/Lower (SOL2) AC & DC Model Lifts, (not shown)
2	RA 1051417/001	Proportional Valve, Lift/Lower (SOL2) AC Lifts Models 7420 & 7440 (not shown)
3	RA 1006072/001	Proportional Valve, Auxiliary Direction (SOL5T & 5B) AC Lift
4	RA 1020607/001	Proportional Valve, Auxiliary Direction (SOL5T & 5B) DC Lift
5	RA 1009200/001	Directional Valve (LS1) AC & DC Lift
6	RA 1011602/001	Main Relief Valve (SOL3) AC Lift (not shown)
7	RA 1009281/007	Main Relief Valve (REL-1) DC Lift
8	RA 1009281/013	Relief Valve (REL-3) Deep Reach Manifold AC & DC Lift
9	RA 1014626/001	Check Valve (CV-1) AC Lift
10	RA 1013281/005	Check Valve (CV-1) DC Lift
11	RA 520-337/004	Check Valve (CV-2) DC Lift
12	RA 520-943	Check Valve (CV-3) Deep Reach Manifold DR32TT (not shown)
13	RA 520-934/002	Load Holding Poppet Valve (SOL1) AC Lift (not shown)
14	RA 1013270/001	Load Holding Poppet Valve (SOL1) DC Lift (not shown)
15	RA 1009208/060	Flow Control Valve (POD1) AC Lift (not shown)
16	RA 1009323/019	Flow Control Valve (CE1) DC Lift
17	RA 520-968	Solenoid Valve, Auxiliary Manifold, Tilt Function, DR32TT
18	RA 1020957/001	Solenoid Valve, Reach Function, DR32TT
19	RA 520-951/003	Solenoid Valve, Tilt & Sideshift, DR32TT
20	RA 591-630	Pressure Switch (HT1) AC & DC Lift
21	RA 1012615/103	Hydraulic Filter DC Lift

Hydraulics - Cylinder

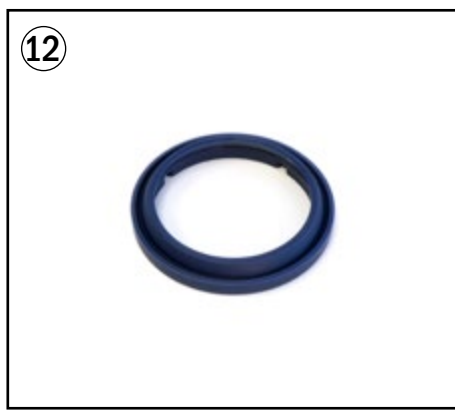
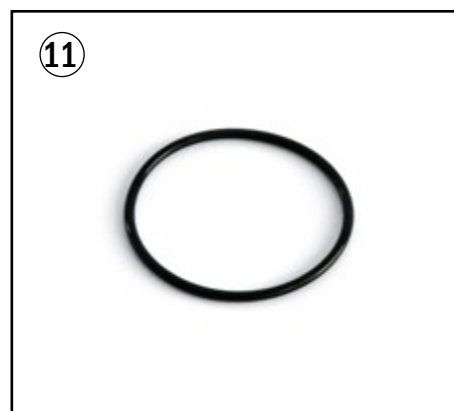
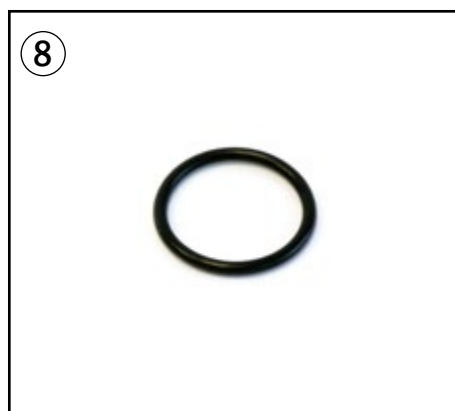
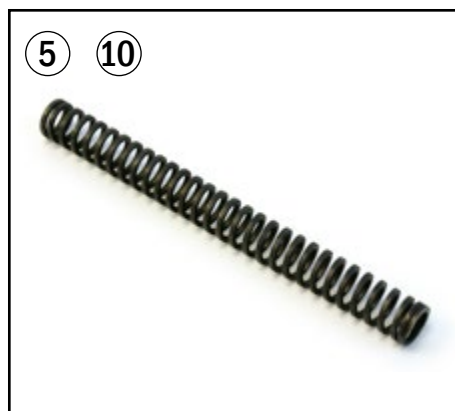
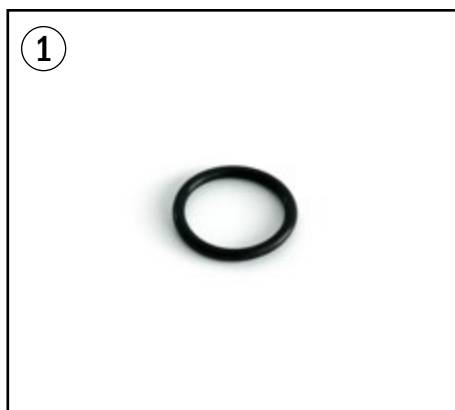

Hydraulics - Cylinder

[back to Contents](#)

Item	Part No.	Date/Serial Range	Description
Model 7400 Main Lift Cylinder			
1	RA 530-534		O-Ring
2	RA 530-633		Seal
3	RA 530-757		Piston Seal
4	RA 531-613		Wiper Seal
5	RA 830-151		Compression Spring
6	RA 780-004-110		Piston Lowering Cushion
7	RA 1075590/01		Seal Kit

Models 7420 & 7440 Main Lift Cylinder			
8	RA 530-533		O-Ring
9	RA 530-633		Seal
10	RA 830-151		Compression Spring
11	RA 1038771		O-Ring
12	RA 1038775		Seal
13	RA 780-004-110		Piston Lowering Cushion
14	RA 1055355/01		Seal Kit

Steered Idler Wheel Assembly

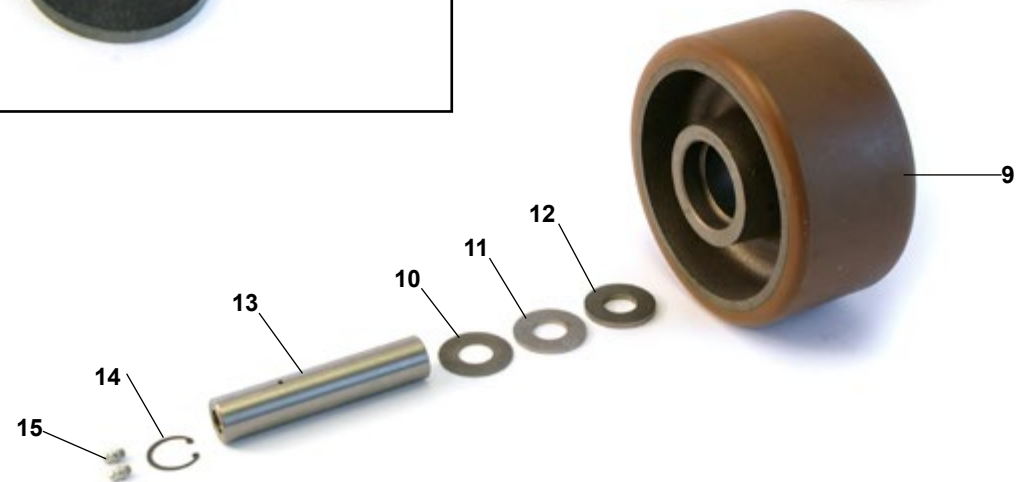
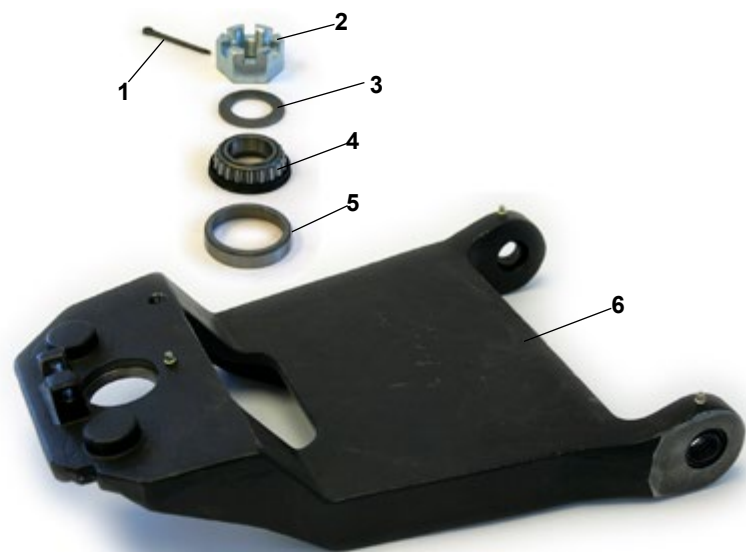
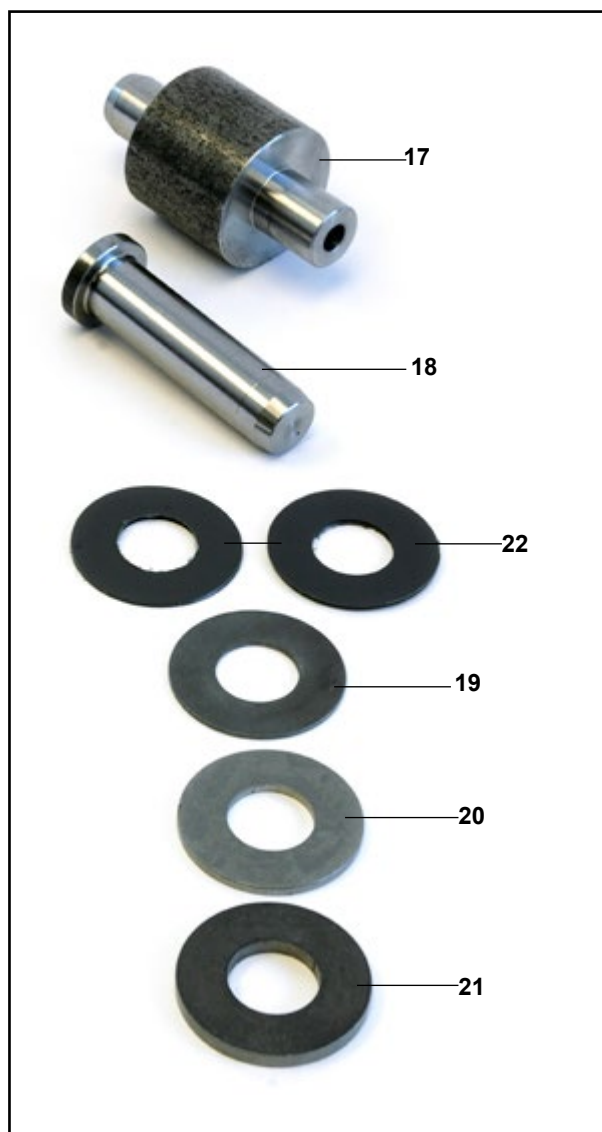

Steered Idler Wheel Assembly

[back to Contents](#)

Item	Part No.	Date/Serial Range	Description
1	RA 810-930		Cotter Pin
2	RA 761-882		Nut
3	RA 812-000-112		Washer
4	RA 447-533		Bearing Cup
5	RA 447-077		Bearing Cone
6	RA 828-013-261		Frame Assembly
7	RA 444-326		Thrust Bearing
8	RA 828-006-696		Caster Housing
9	RA 632-078/007		Caster Wheel, 8" x 4", 95-A
	RA 632-078/007-A		Caster Wheel, 8" x 4", 95-A w/ Bearings
	RA 632-078/107		Caster Wheel, 8" x 4", 97-A XL
	RA 632-078/107-A		Caster Wheel, 8" x 4", 97-A XL w/ Bearings
10	RA 828-000-260/003		Caster Wheel Shim, 0.03" Thick
11	RA 828-000-260/002		Caster Wheel Shim, 0.06" Thick
12	RA 828-000-260/001		Caster Wheel Shim, 0.12" Thick
13	RA 828-006-728		Caster Axle
14	RA 810-022		Retaining Ring
15	RA 840-030		Lube Fitting
16	RA 830-218		Compression Spring
17	RA 1011137		Pivot Pin, Inboard
18	RA 828-003-078		Pivot Pin, Outboard
19	RA 828-000-225/001		Shim, 0.06" Thick
20	RA 828-000-225/002		Shim, 0.12" Thick
21	RA 828-000-225/003		Shim, 0.19" Thick
22	RA 828-003-701		Spacer

Steering Linkage



Steering Linkage

Item	Part No.	Description
1	RA 1009381	Center Link Assembly, Includes Bearing (Item 2)
2	RA 445-118	Needle Bearing
3	RA 1009401	Steering Link Assembly (Caster Side), Includes Bearing, Spherical Roller (Item 4)
4	RA 460-680	Bearing, Spherical Roller
5	RA 1009403	Steering Link Assembly (Drive Side), Includes Bearing, Spherical Roller (Item 4)
6	RA 840-030	Lube Fitting
7	RA 824-000-382	Bolt
8	RA 824-000-390	Spacer

Electrical System

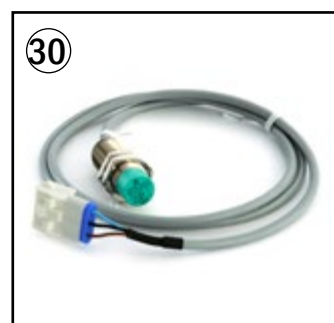
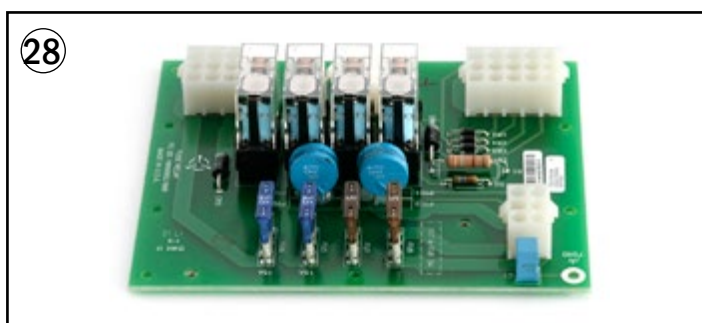
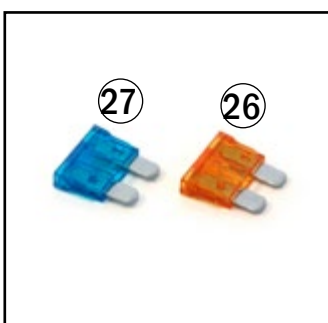
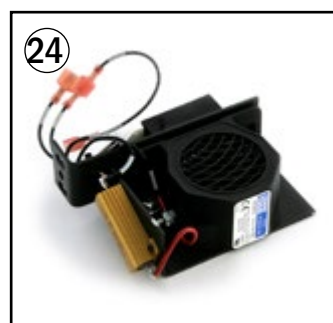
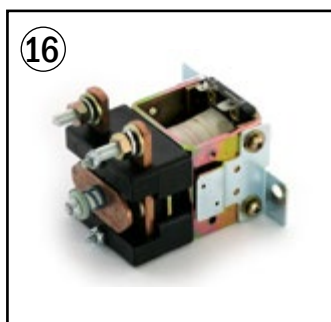
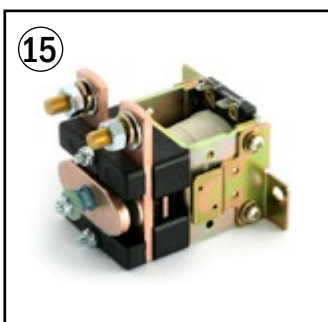
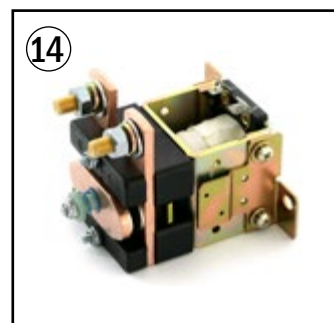
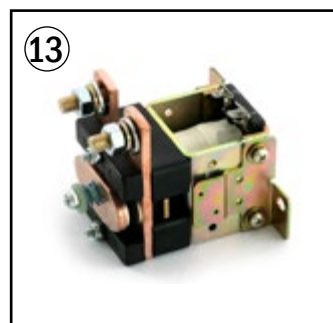
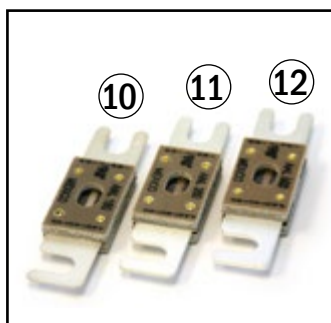
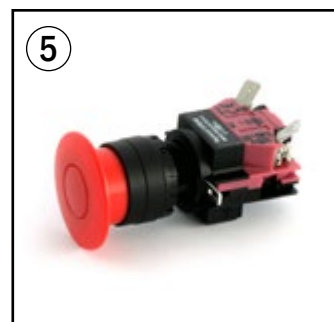

Electrical System

Item	Part No.	Description
1	RA 1052451	Fan Assembly, Drive Motor Compartment, Models 7420 & 7440
2	RA 1010845	Fan Assembly, Drive Motor Compartment EE (not shown), Model 7400
3	RA 1018881	Fan Assembly, Lift Motor Compartment, AC Lift (not shown)
4	RA 1005525/004	Card Assembly, Circuit, Steer Amplifier, AC Lift
5	RA 1-150-313/057	Switch, EPO, All Models
6	RA 1013789/001	Temperature Sensor, DC Lift Motor
7	RA 1014593/003	Power Amplifier, Traction (not shown)
8	RA 1015187/003	Power Amplifier, Lift (not shown)
9	RA 1019283/005	Vehicle Manager Assembly (not shown)
10	RA 590-587/109	Fuse, FU1 150 amp, AC & DC Lift
11	RA 590-587/117	Fuse, FU2 350 amp, AC & DC Lift
12	RA 590-587/119	Fuse, FU3 500 amp, AC & DC Lift
13	RA 1012353	Contactor, 300 amp, TPC, AC & DC Lift
14	RA 1-105-153/100	Contactor, 300 amp, LPC, DC Lift
15	RA 1-105-154/100	Contactor, 300 amp, STR, DC Lift
16	RA 1-105-232/100	Contactor, 100 amp AC Lift
17	RA 1-105-129/111	Kit, Contactor Tip, 300 amp
18	RA 1-105-131/111	Kit, Contactor Tip, 100 amp
19	RA 1-105-122/03	Spring, Contactor Main
20	RA 1009195/006	Display, Operator Fore-Aft (not shown)
21	RA 1016511/004	Display, Operator Side Stance (not shown)
22	RA 590-643/005	Horn, 36V Mechanical
23	RA 590-633	Horn, 36V Electronic (not shown)
24	RA 828-013-737/002	Horn, Assembly 36V Electronic
25	RA 114-008-306	Key Switch, 2-Position
26	RA 590-585/005	Fuse, FU7 & FU8, 5 amp
27	RA 590-585/008	Fuse, FU5 & FU6, 15 amp (Replaces 10 amp)
28	RA 1022159/004	Panel Assembly, Auxiliary Power, Relay/Control Fuse Panel
29	RA 1031427/002	Proximity Switch, S/N 742-07-CA09583 & Lower (S12) (not shown)
30	RA 1031427/001	Proximity Switch, S/N 742-07-CA09584 & Higher (S12)

Steering & Controls

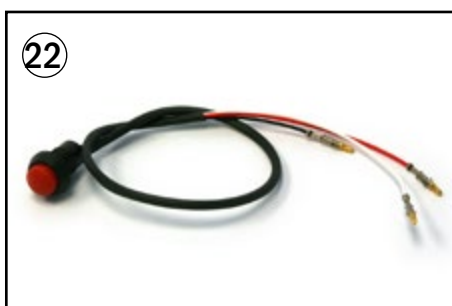
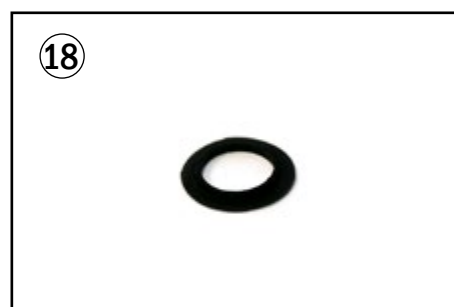
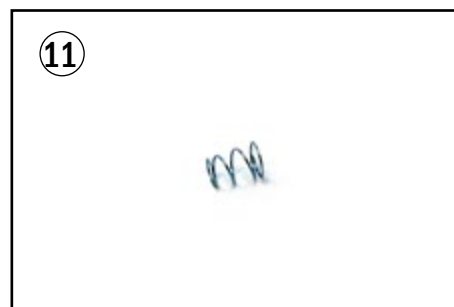

Steering & Controls

[back to Contents](#)

Item	Part No.	Description
1	RA 830-052	Tension Spring
2	RA 1012203	Steering Encoder
3	RA 1019433	Hydraulic Steer Motor, DC Lift, Fore-Aft (not shown)
4	RA 1019447	Hydraulic Steer Motor, DC Lift, Side Stance (not shown)
5	RA 1013151/01	Seal Kit, Hydraulic Steer Motor, DC Lift
6	RA 1016481/450	Steer Motor, Standard, AC Lift (not shown)
7	RA 1016482/450	Steer Motor, EE, AC Lift (not shown)
8	RA 1016523/215	Brush Set, Steer Motor, AC Lift
9	RA 1018414/102	Control Handle Assembly, Side Stance, Primary Standard
10	RA 1018414/104	Control Handle Assembly, Side Stance, Cold Storage, Primary (not shown)
11	RA 1014993	Compression Spring, Side Stance, Primary
12	RA 1015005	Torsion Spring, Travel Potentiometer, Side Stance, Primary
13	RA 1015196	Torsion Spring, Lift Potentiometer, Side Stance, Primary
14	RA 1017546/001	Resistor, Variable (VR1), Side Stance, Travel Potentiometer
15	RA 1017546/003	Resistor, Variable (VR2), Side Stance, Lift Potentiometer
16	RA 1052043	Bearing Sleeve, Control Handle, Side Stance
17	RA 1024359/002	Control Handle Circuit Control Card Assembly, Side Stance (not shown)
18	RA 1029121	O-Ring, Control Handle, Side Stance, Primary
19	RA 1017843/001	Control Handle Assembly, Fore-Aft Stance, Secondary (not shown)
20	RA 1018263	Torsion Spring, Travel Potentiometer, Fore-Aft Stance (not shown)
21	RA 1017841/001	Resistor, Variable (VR3), Travel Potentiometer, Fore-Aft Stance
22	RA 1020056	Switch, Push Button, Horn, Fore-Aft Stance, Secondary

Mast & Reach Carriage



Mast & Reach Carriage

[back to Contents](#)

Item	Part No.	Description
Mast & Reach Carriage R35TT		
1	RA 443-027	Bearing, Chain Pulley Sheave
2	RA 449-015	Bearing, Mast Roller
3	RA 449-025	Bearing, Mast Roller
Mast & Reach Carriage R45TT, DR32TT & 7400		
4	RA 1004705	Bumper Mast
5	RA 1009451	Pad, Kickback
6	RA 1009950	Bow Pad
7	RA 1012605	Pad, Kickback
8	RA 443-027	Bearing, Chain Pulley Sheave
9	RA 449-032	Bearing, Mast Roller
10	RA 1017244/001	Belt, Drive Height Encoder 7400 (Mast 87" to 95")
11	RA 1017244/002	Belt, Drive Height Encoder 7400 (Mast 96" to 100", not shown)
12	RA 1017244/003	Belt, Drive Height Encoder 7400 (Mast 101" to 106", not shown)
13	RA 1017244/004	Belt, Drive Height Encoder 7400 (Mast 107" to 119", not shown)
14	RA 1017244/005	Belt, Drive Height Encoder 7400 (Mast 120" to 131", not shown)
15	RA 1017244/006	Belt, Drive Height Encoder 7400 (Mast 132" to 146", not shown)
16	RA 1017244/007	Belt, Drive Height Encoder 7420 & 7440 (Mast 162" to 184", not shown)
17	RA 830-052	Tension Spring
18	RA 1061151	Bearing Encoder (7400, 7420 & 7440)
19	RA 444-326	Thrust Bearing (not shown)
20	RA 444-416	Thrust Bearing Open (not shown)
21	RA 448-221	Roller Bearing
22	RA 460-690	Spherical Bearing
23	RA 460-696	Spherical Bearing
24	RA 1012503	Cylindrical Bearing
25	RA 460-476	Bearing, Bushing Oil Impregnated
26	RA 1022278	Track Bearing, Carriage
27	RA 1020738	Track Bearing, Carriage

Battery Compartment

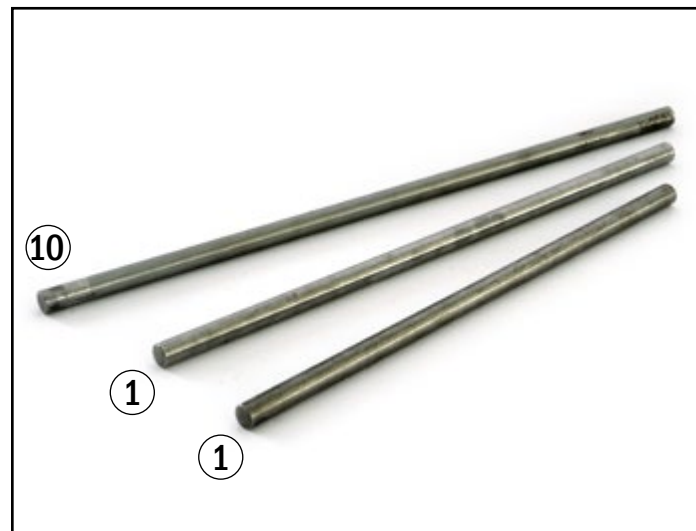
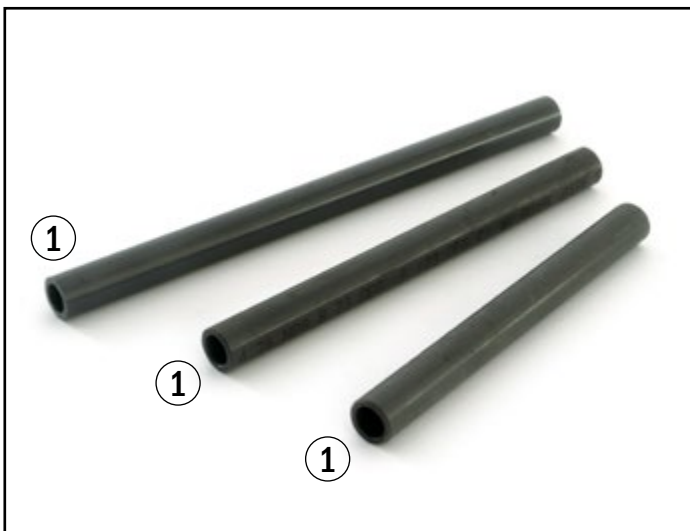

Battery Compartment

[back to Contents](#)

Item	Part No.	Description
------	----------	-------------

Battery Roller Assembly

1	RA 123-001-382	Battery Roller
2	RA 828-006-727/001	Battery Roller Assembly (16.5" Compartment)
3	RA 828-006-727/006	Battery Roller Assembly (18.5" Compartment, not shown)
4	RA 828-006-727/002	Battery Roller Assembly (21.5" Compartment, not shown)
5	RA 828-001-429/004	Spacer, 10.5" for 16.5" Compartment
6	RA 828-001-429/005	Spacer, 15.5" for 18.5" Compartment
7	RA 828-001-429/011	Spacer, 12.5" for 21.5" Compartment
8	RA 828-001-335/009	Shaft, Roller for 16.5" Compartment
9	RA 828-001-335/013	Shaft, Roller for 18.5" Compartment
10	RA 828-001-335/010	Shaft, Roller for 21.5" Compartment
11	RA 590-724	Battery Connector Assembly 350 amp 2/0 (Gray)
12	RA 590-725	Battery Connector Assembly 350 amp 2/0 (Yellow)
13	RA 590-726	Battery Connector Assembly 350 amp 2/0 (Red)
14	RA 590-739	Battery Connector Assembly 350 amp 2/0 (Blue)

AC Lift Connectors

15	RA 590-755/001	Battery Connector Assembly 350 amp 3/0 (Gray)
16	RA 590-755/004	Battery Connector Assembly 350 amp 3/0 (Yellow)
17	RA 590-755/003	Battery Connector Assembly 350 amp 3/0 (Red)
18	RA 590-755/002	Battery Connector Assembly 350 amp 3/0 (Blue)



800-462-2370

www.SuperStoresService.com